



MAINSTAYS ROUND TABLE

STOCK # MS1302125171002 (BLACK FINISH)

STOCK # MS1302125171003 (WALNUT FINISH)



15 minute approx
assembly time

Adult
assembly required

MAXIMUM LOAD
165 LB. (75 KG)

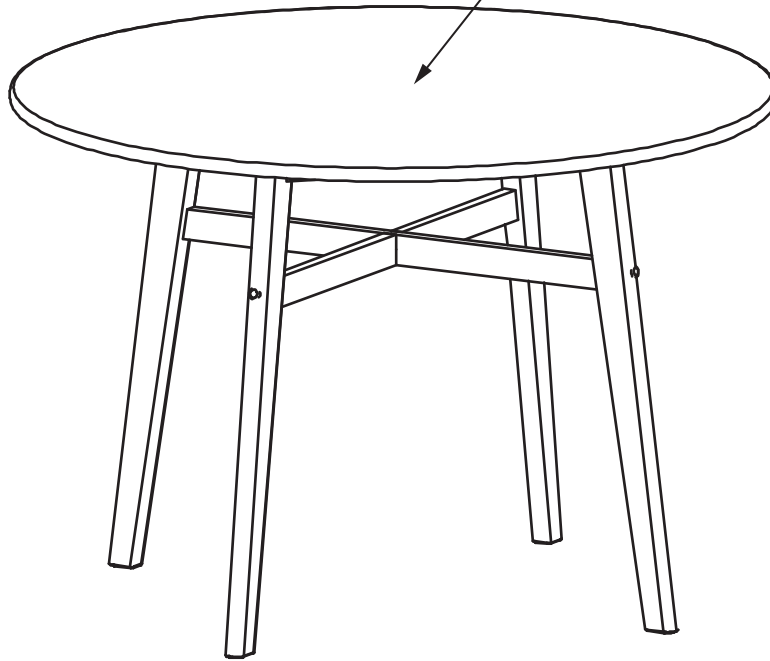

THIS INSTRUCTION BOOKLET CONTAINS **IMPORTANT** SAFETY INFORMATION.
PLEASE READ AND KEEP FOR FUTURE REFERENCE.

- If you have any question regarding assembly, please call our toll-free number for assistance.
- DO NOT RETURN THE PRODUCT TO THE STORE, individual stores do not stock parts. If a part is missing or damaged, please call **1-877-637-3590** or send e-mail to **asprod2015@gmail.com** and have your instructions, parts list ready to provide the model name, part name.
- Parts will be shipped FREE of charge within 90 days of the purchase with proof of purchase.
- Additional parts are available for a fee.

Stock # MS1302125171002 (Black)

Stock # MS1302125171003 (Walnut)

Lot Number: _____

Date Purchased: ___/___/___

Review your purchases, thank you!

★★★★★

Share your feedback to help other shoppers
Link for this product is as below:
www.walmart.com



Manufactured By: Saigon Furniture Co.,Ltd.
Dong Nai, Vietnam.
TEL: 1-877-637-3590 EMAIL: asprod2015@gmail.com



We are available to assist you Monday - Friday
from 9:00 am - 5:00 pm Eastern Standard Time.
1-877-637-3590



MAINSTAYS ROUND TABLE

STOCK # MS1302125171002 (BLACK FINISH)
STOCK # MS1302125171003 (WALNUT FINISH)



Quality Guarantee

Should this product be defective in workmanship, materials or fail under normal use, we will send replacement parts (excluding table top) for up to one (1) year from the date of purchase. If you have issues with your table top, please return the dining set to Walmart within their Return Policy guideline. Every Saigon Furniture product is designed to meet your highest expectations. We guarantee that you will be satisfied with your purchase.

This warranty gives you specific legal rights and you may also have other rights which vary from State to State.

The warranty applies to Walmart customer who purchased the product from Walmart stores or Walmart.com with proof of purchase only.



General Information, Tips & Tricks

- Read and understand all the steps carefully before starting.
- Please follow the steps in the correct orders to avoid difficulties or damages to the parts during assembly. If each step is not followed in the correct order the assembly will be difficult and may result in damages.
- Make sure all the parts are included. Most boards are labeled with a removable sticker.
- Work in a spacious area, preferably on a carpeted surface, near where the unit will be used.
- Please wait until all steps are completed before tightening bolts.
- Please make sure all bolts are tightly fastened before the unit is used.
- Looking for online assembly instructions ? you can access the link:
<https://www.saigon-furniture.com/customer-care>



Safety and care

- Do not allow children to climb or play on the unit.
- Clean the product with your favorite furniture polish and a soft cloth.
- Do not use harsh chemicals or abrasive cleaners.
- Move your new furniture carefully with two people. Never push or drag the unit.

DO NOT USE POWER TOOLS TO ASSEMBLE YOUR FURNITURE. POWER TOOLS MAY DAMAGE THE PARTS AND RESULT IN DAMAGE.



Help and support

- If you have any question regarding assembly, please call our toll-free number for assistance.
- DO NOT RETURN THE PRODUCT TO THE STORE, individual stores do not stock parts.
- If a part is missing or damaged, please call **1-877-637-3590** or send e-mail to **asprod2015@gmail.com** and have your instructions, parts list ready to provide the model name, part name.
- Parts will be shipped FREE of charge within 90 days of the purchase with proof of purchase.
- Additional parts are available for a fee.



Parts and Hardware List

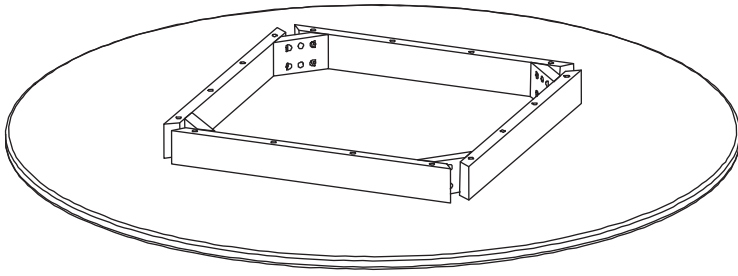

A Table Top x1



B Table Leg x4

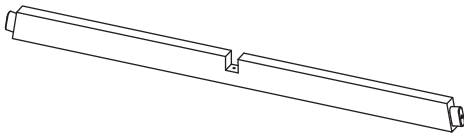

C Upper Stretcher x1

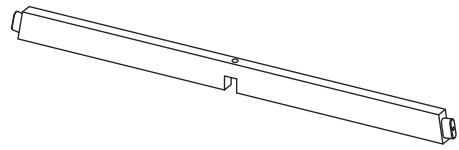

D Lower Stretcher x1

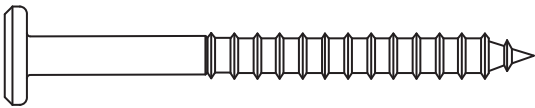

1 M6x70mm Screw x4

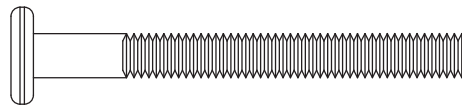

2 M6x60mm Bolt x8



3 Lock Washer x8

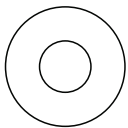

4 Flat Washer x8

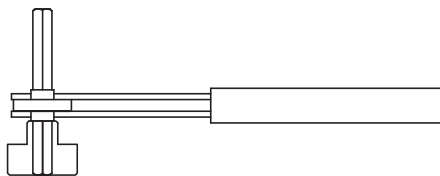

5 M4 Ratchet Wrench x1

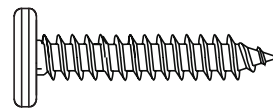

6 M6x30mm Screw x1

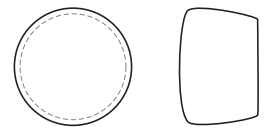

7 Wood Plugs x4

Table Assembly

1

1. Align and attach Table Leg (B) to Upper Stretcher (C) with Screws (1).
Tighten the Screws by using Ratchet Wrench (5).
2. Align and attach Table Leg (B) to Lower Stretcher (D) with Screws (1).
Tighten the Screws by using the Ratchet Wrench (5).

Note: Do not fully tighten the Screws at this stage.



DO NOT USE POWER DRILL / DRIVERS FOR INSERTING SCREWS / BOLTS AS THIS COULD DAMAGE THE UNIT. ONLY USE RATCHET WRENCH PROVIDED !

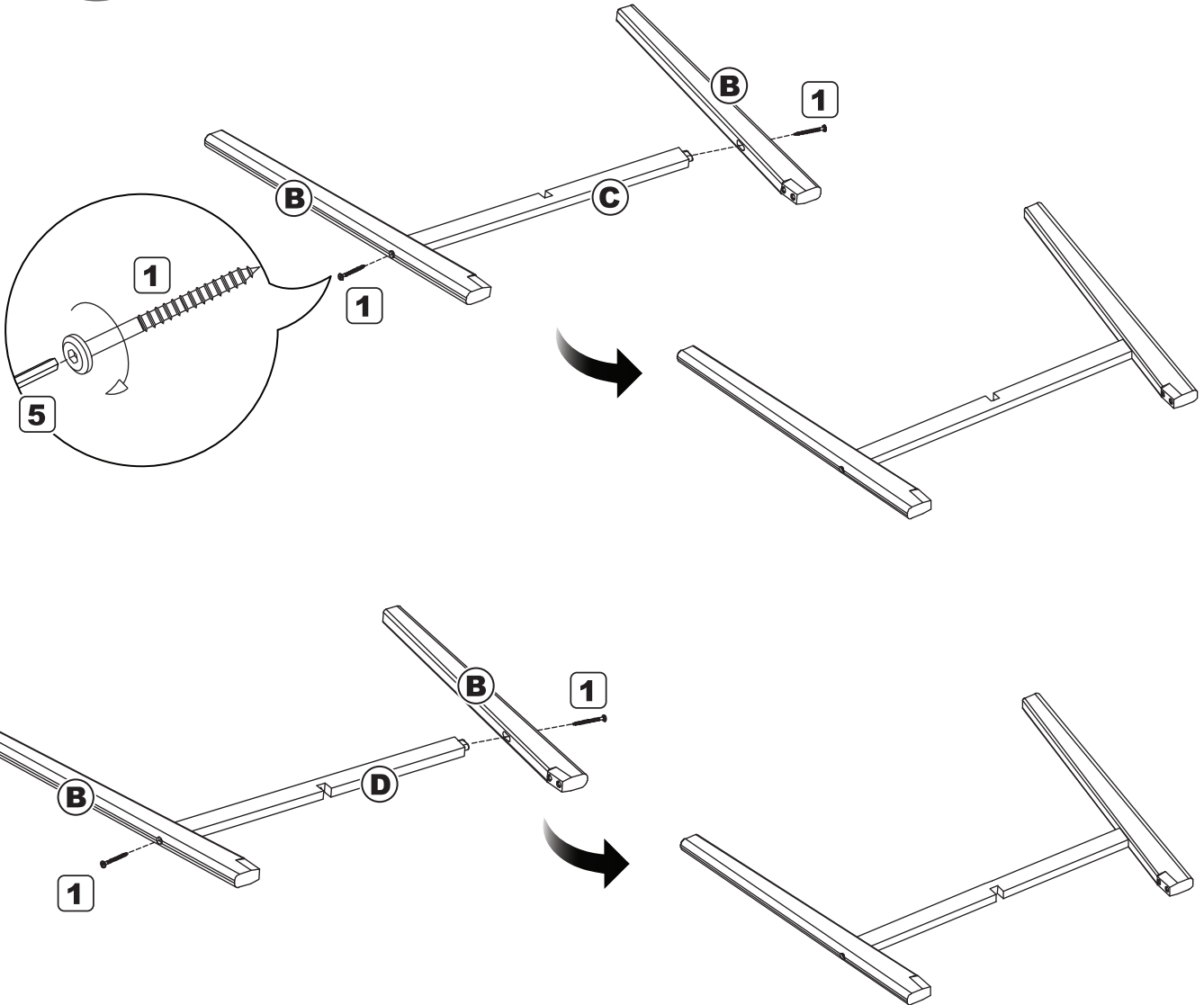

1

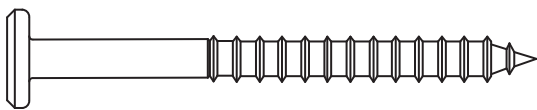

M6x60mm Bolt x4

5

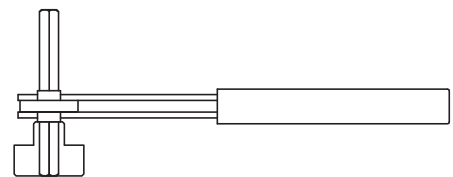

M4 Ratchet Wrench x1

Table Assembly

2

Align and attach the assembled leg frame (B, C) to Table Top (A) with Bolts (2), Lock Washers (3), Flat Washers (4). Tighten the Bolts by using the Ratchet Wrench.

Note: Do not fully tighten the Bolts at this stage.

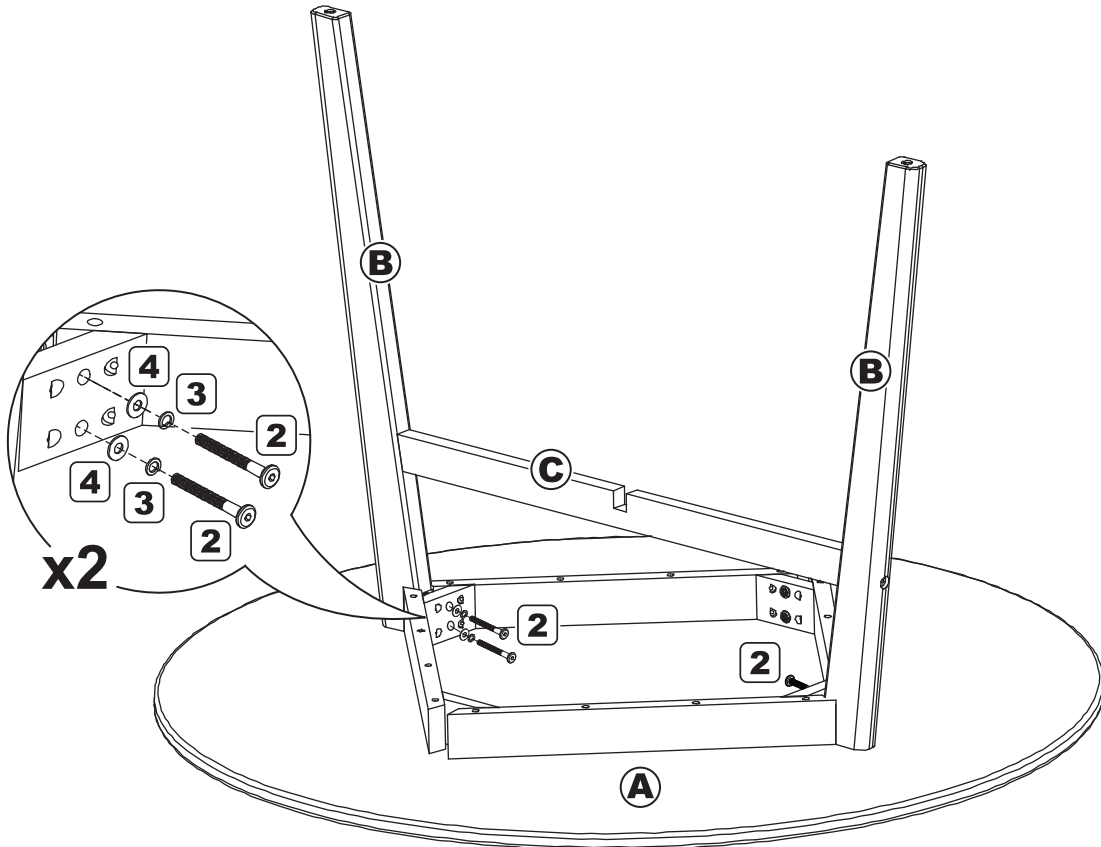

2

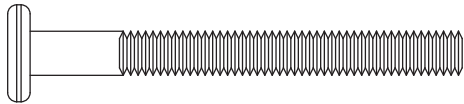

M6x60mm Bolt x4

3



Lock Washer x4

4

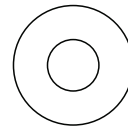

Flat Washer x4

5

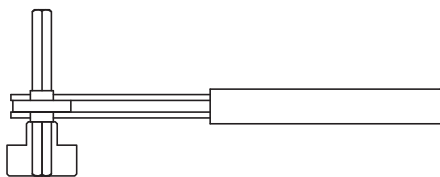

M4 Ratchet Wrench x1

Table Assembly

3

1. Align and attach the assembled leg frame (B, D) to Table Top (A) with Bolts (2), Lock Washers (3), Flat Washers (4). Tighten the Bolts by using the Ratchet Wrench.
2. Secure the Lower Stretcher (D) and the Upper Stretcher (C) with Screw (6). Tighten the Screw by using the Ratchet Wrench.
3. Then, fully tighten all the Bolts, Screws.

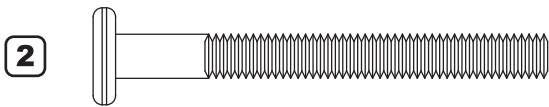
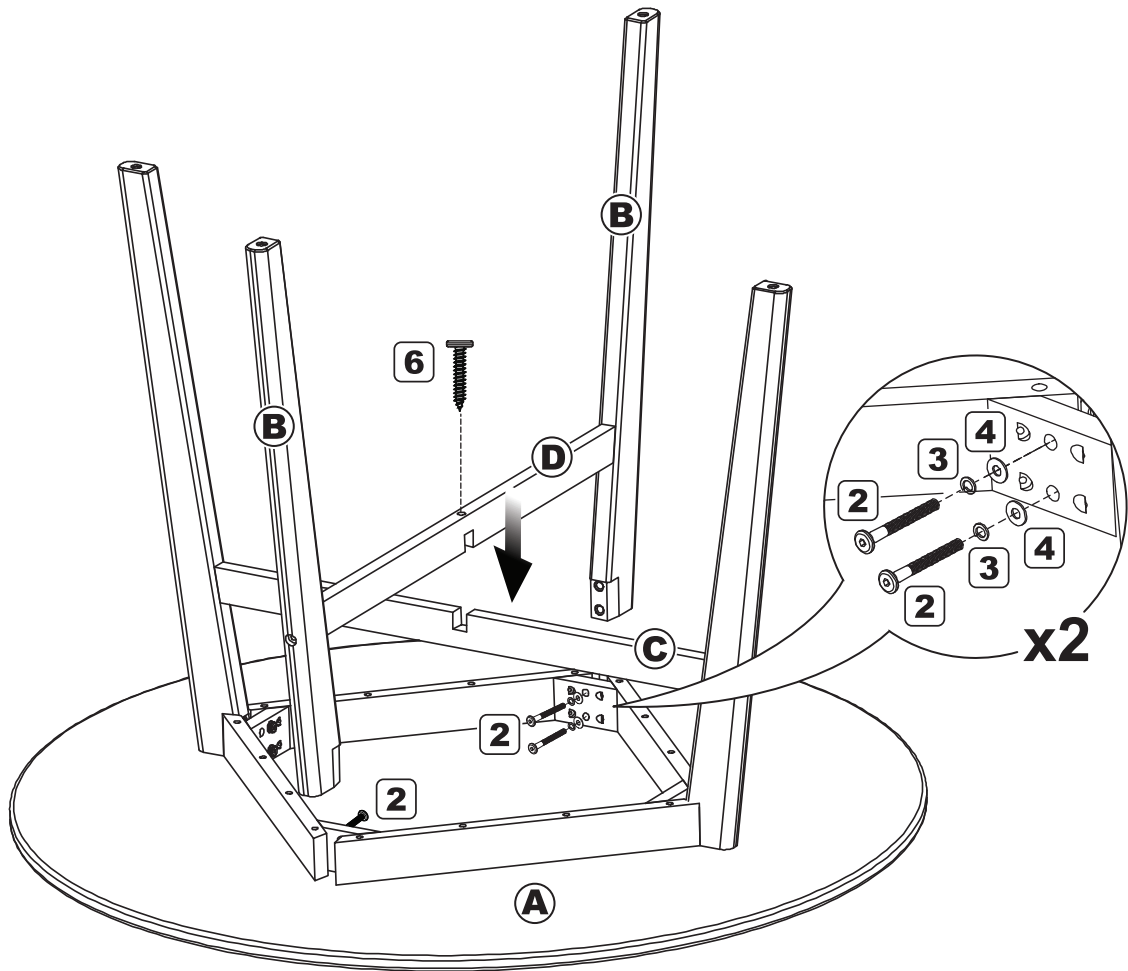

M6x60mm Bolt x4



Lock Washer x4

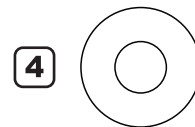

Flat Washer x4

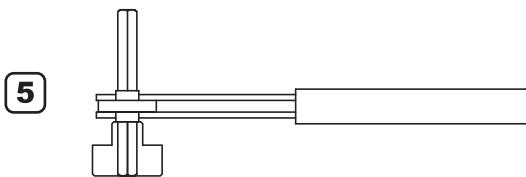

M4 Ratchet Wrench x1

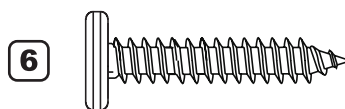

M6x30mm Screw x1

Table Assembly

4

1. Stand the Table upright.
2. Cover all Screw holes of the Table Legs with Wood Plugs (7).

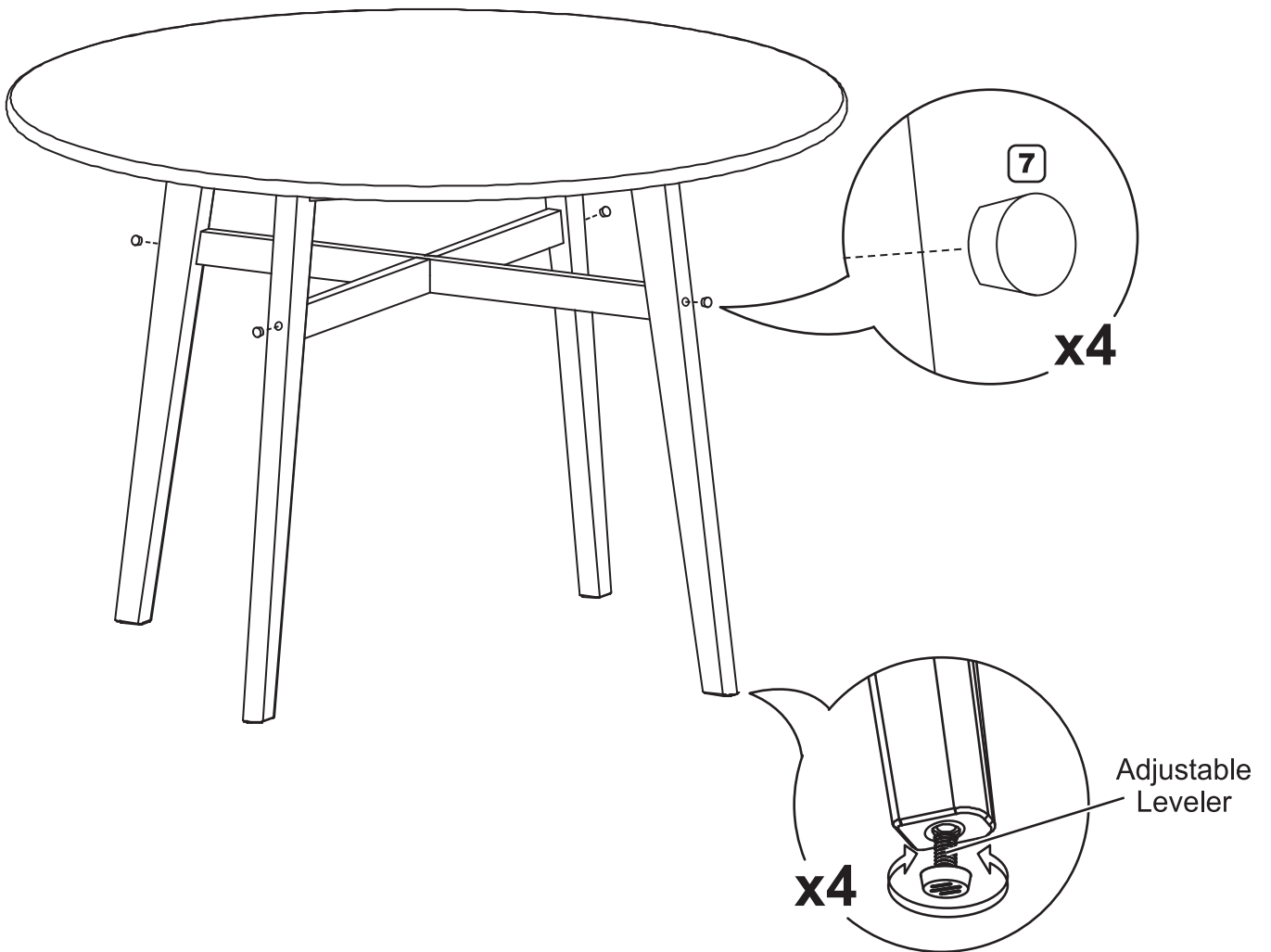

7

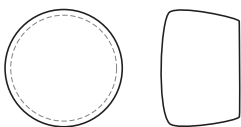

Wood Plugs x4

Replacement Parts

STOCK # MS1302125171002 (BLACK FINISH)
STOCK # MS1302125171003 (WALNUT FINISH)

IF YOU NEED TO ORDER ANY PARTS PLEASE USE THE LIST BELOW.

Please email defect photos and proof of purchase to asprod2015@gmail.com

Parts will be shipped FREE of charge within 90 days of the purchase with proof of purchase.

Spare parts and services only support the purchase made from Walmart Store or Walmart.com

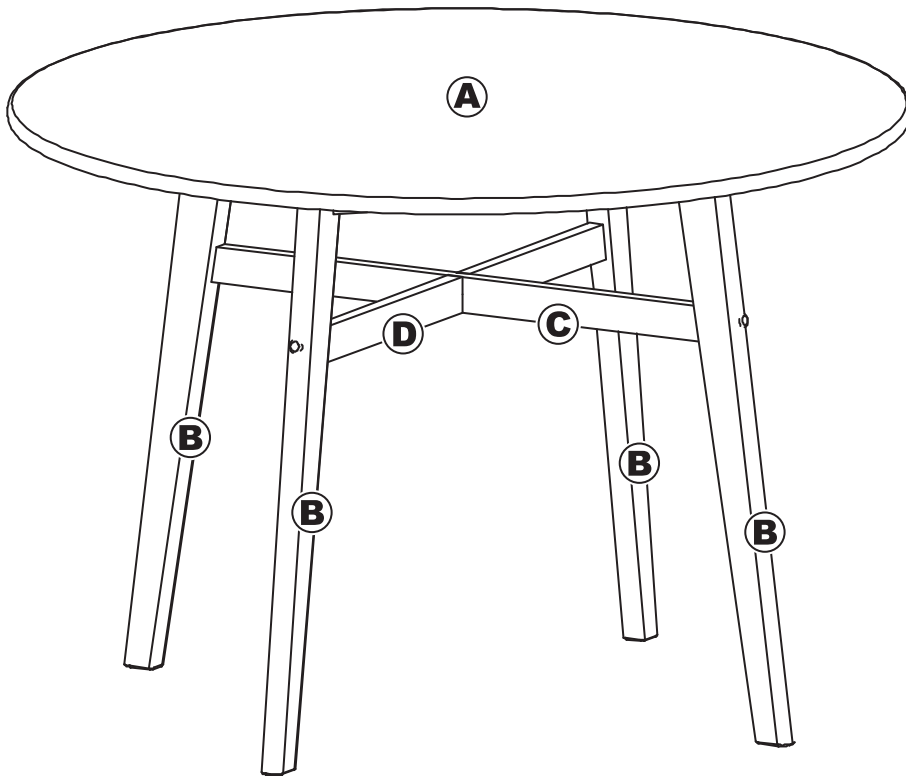

Parts

- A** Table Top
- B** Table Leg
- C** Upper Stretcher
- D** Lower Stretcher

- 1** M6x70mm Screw
- 2** M6x60mm Bolt
- 3** Lock Washer
- 4** Flat Washer
- 5** M4 Ratchet Wrench
- 6** M6x30mm Screw
- 7** Wood Plugs

Hardware

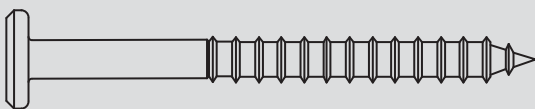

1

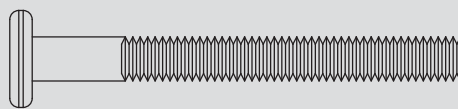

2



3



4

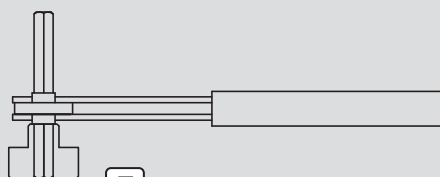

5

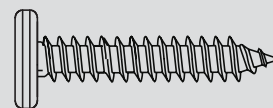

6



7



MAINSTAYS - MESA REDONDA

MODELO # MS1302125171002 (ACABADO NEGRO)

MODELO # MS1302125171003 (ACABADO NOGAL)



15 minutos aprox.
tiempo de ensamblaje



Requiere montaje
para adultos

**MAXIMA CARGA
165 LB. (75 KG)**

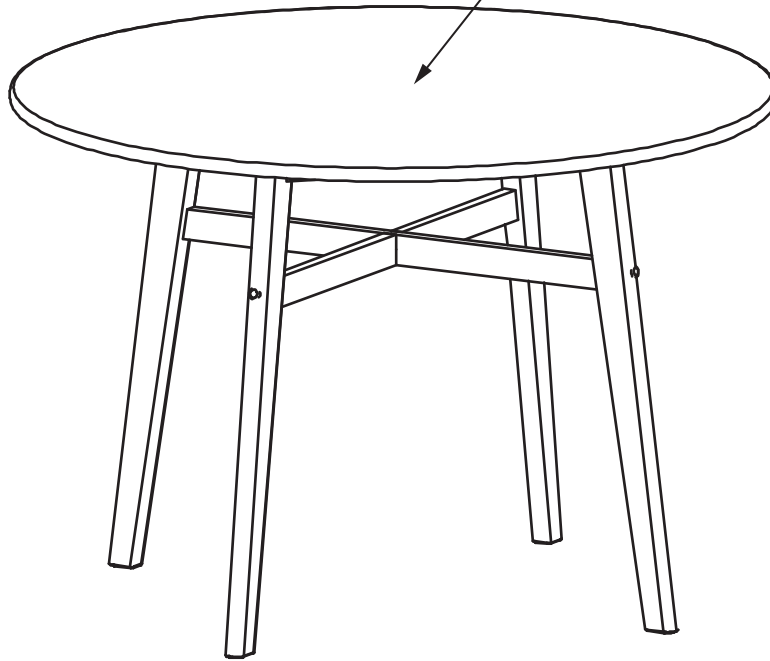

ESTE LIBRO DE INSTRUCCIONES CONTIENE INFORMACIÓN **IMPORTANTE** DE SEGURIDAD. POR FAVOR LEA Y MANTENGA PARA FUTURAS REFERENCIAS.

- Si tiene preguntas o dudas referentes al ensamble, llame a nuestro número gratuito para obtener más ayuda.
- NO RETORNE ESTE PRODUCTO A LA TIENDA; las tiendas no cuentan con partes del producto. Para piezas perdidas o dañadas llame al, por favor llame al **1-877-637-3590** o envíe un correo electrónico a: **asprod2015@gmail.com** de ayuda al cliente teniendosu instructivo y lista de partes para proveer el modelo, nombre de parte o el número de Fábrica
- Las piezas se enviarán GRATIS dentro de los 90 días de la compra con el comprobante de compra.
- Piezas adicionales están disponibles por una tarifa.

Modelo # MS1302125171002 (Negro)

Modelo # MS1302125171003 (Nogal)

Lote No: _____

Fecha De Compra: ___/___/___

Revisar sus compras, gracias!



Comparta sus comentarios para ayudar a otros compradores. El enlace para este producto es el siguiente www.walmart.com



Para el servicio de atención al cliente en línea, escanee el código QR con su teléfono inteligente.
Escanéame!

Fabricante: Saigon Furniture Co.,Ltd.
Dong Nai, Vietnam.

TEL: 1-877-637-3590 EMAIL: asprod2015@gmail.com



Estamos disponibles para ayudarlo de Lunes -Voermes de 9:00 am - 5:00 pm Hora de la Zona Este.
1-877-637-3590

Página 1/8



MAINSTAYS - MESA REDONDA

MODELO # MS1302125171002 (ACABADO NEGRO)

MODELO # MS1302125171003 (ACABADO NOGAL)



Garantía De Calidad

Si este producto tiene defectos de mano de obra, materiales o falla durante el uso normal, le enviaremos piezas de repuesto (excepto el tablero de la mesa) hasta por un (1) año a partir de la fecha de compra. Si usted tiene problemas con su mesa, devuelva el juego de comedor a Walmart de acuerdo con su política de devoluciones. Cada producto de Saigon Furniture está diseñado para satisfacer sus más altas expectativas. Garantizamos que usted estará satisfecho con su compra. Esta garantía le otorga derechos legales específicos y también puede tener otros derechos que varían de Estado a estado. La garantía se aplica al cliente de Walmart que compró el producto en tiendas Walmart o Walmart.com solo con comprobante de compra.



Información General Y Recomendaciones De Uso

- Leer y entender todos los pasos cuidadosamente antes de comenzar.
- Si no se sigue cada paso en el orden correcto, el montaje será difícil y puede ocasionar daños.
- Trabajar en una zona amplia, mejor sobre la alfombra, cerca del sitio donde la unidad se utiliza.
- Asegurarse de que todas las piezas estén incluidos. La mayoría de los tableros están etiquetados con una pegatina removible.
- Por favor espere a terminar de montar todas las piezas, antes de apretar completamente todos los tornillos.
- Asegúrese que todos los tornillos estén bien apretados antes de utilizar la unidad.
- Buscas las Instrucciones de construcción digitales ? Por favor consulte:
<https://www.saigon-furniture.com/customer-care>



Seguridad y cuidado

- Limpiar el producto con tu pulidor favorite de mueble y un trapo blando.
- No usar químicos fuertes o producto de limpieza abrasivo.
- Mueva sus nuevos muebles cuidadosamente con dos personas, nunca empuje o
- Arrastre la unidad.

NO UTILICE HERRAMIENTAS ELÉCTRICAS
PARA MONTAR SUS MUEBLES.
HERRAMIENTAS ELÉCTRICAS PUEDEN
DAÑAR LAS PIEZAS Y PROVOCAR DAÑOS



Ayudar y apoyar

- Si tiene preguntas o dudas referentes al ensamble, llame a nuestro número gratuito para obtener más ayuda.
- NO RETORNE ESTE PRODUCTO A LA TIENDA; las tiendas no cuentan con partes del producto.
- Para piezas perdidas o dañadas llame al, por favor llame al **1-877-637-3590** o envíe un correo electrónico a: **asprod2015@gmail.com** de ayuda al cliente teniendosu instructivo y lista de partes para proveer el modelo, nombre de parte o el número de Fábrica.
- Las piezas se enviarán GRATIS dentro de los 90 días de la compra con el comprobante de compra.
- Piezas adicionales están disponibles por una tarifa.



Lista de Partes y Herraje

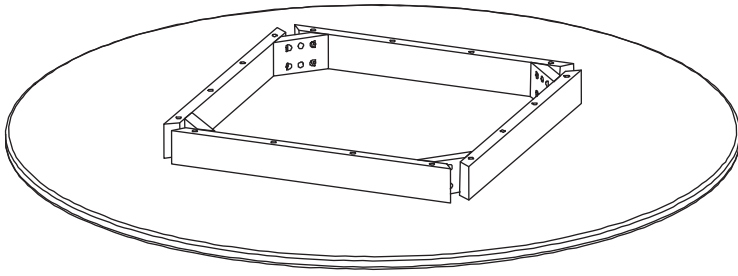

A Mesa x1



B Pata de la mesa x4

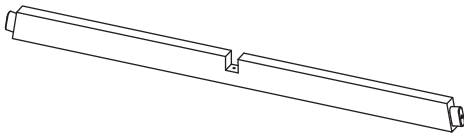

C Barra superior x1

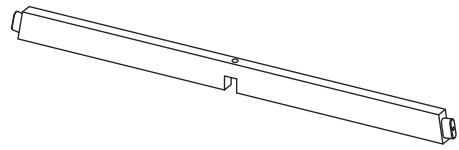

D Barra inferior x1

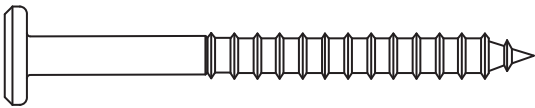

1 M6x70mm Tornillo p/Madera x4

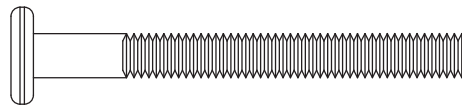

2 M6x60mm Tornillo De x8



3 Arandela Candado x8

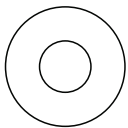

4 Arandela Plana x8

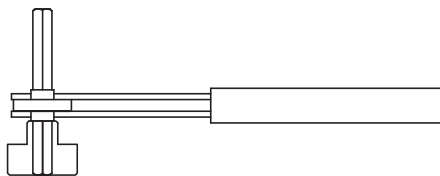

5 M4 Llave Ratchet x1

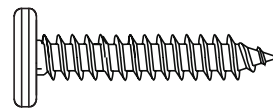

6 M6x30mm Tornillo p/Madera x1

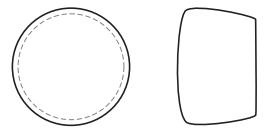

7 Tapones De Madera x4

Instrucciones De Montaje Para La Mesa

1

1. Alinee y fije la Pata de la mesa (B) a la Barra superior (C) con Tornillo p/Madera (1).
Apriete los tornillos usando la M4 Llave ratchet (5).
2. Alinee y fije la Pata de la mesa (B) a la Barra inferior (D) con Tornillo p/Madera (1).
Apriete los Tornillos usando la M4 Llave ratchet (5).

Nota: No apriete completamente los Tornillos en esta etapa.



NO UTILICE HERRAMIENTAS ELÉCTRICAS PARA MONTAR SUS MUEBLES. HERRAMIENTAS ELÉCTRICAS PUEDEN DAÑAR LAS PIEZAS Y PROVOCAR DAÑOS

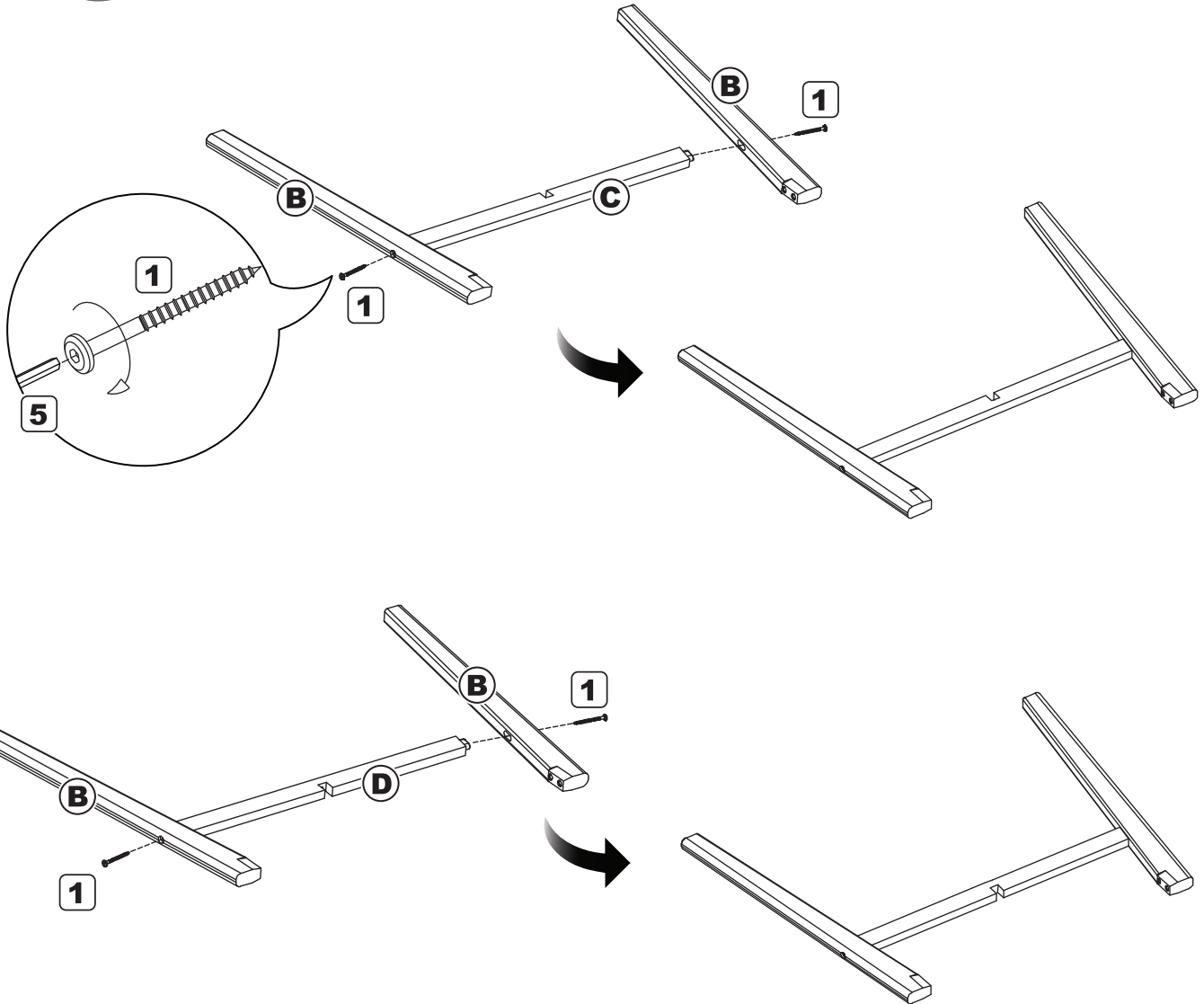

1

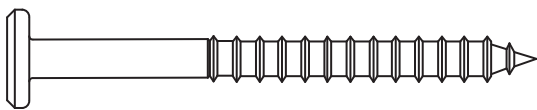

M6x70mm Tornillo p/Madera x4

5

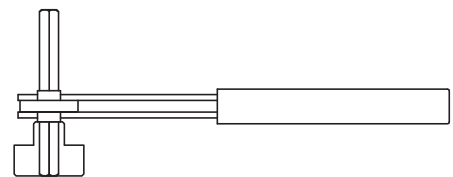

M4 Llave ratchet x1

Instrucciones De Montaje Para La Mesa

2

Alinee y fije el marco de la pata ensamblada (B, C) a la parte superior de la Mesa (A) con Tornillo De (2), Arandela Candado (3), Arandela Plana (4).

Apriete los pernos con la Llave Ratchet.

Nota: No apriete completamente los Pernos en esta etapa.

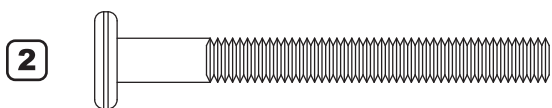
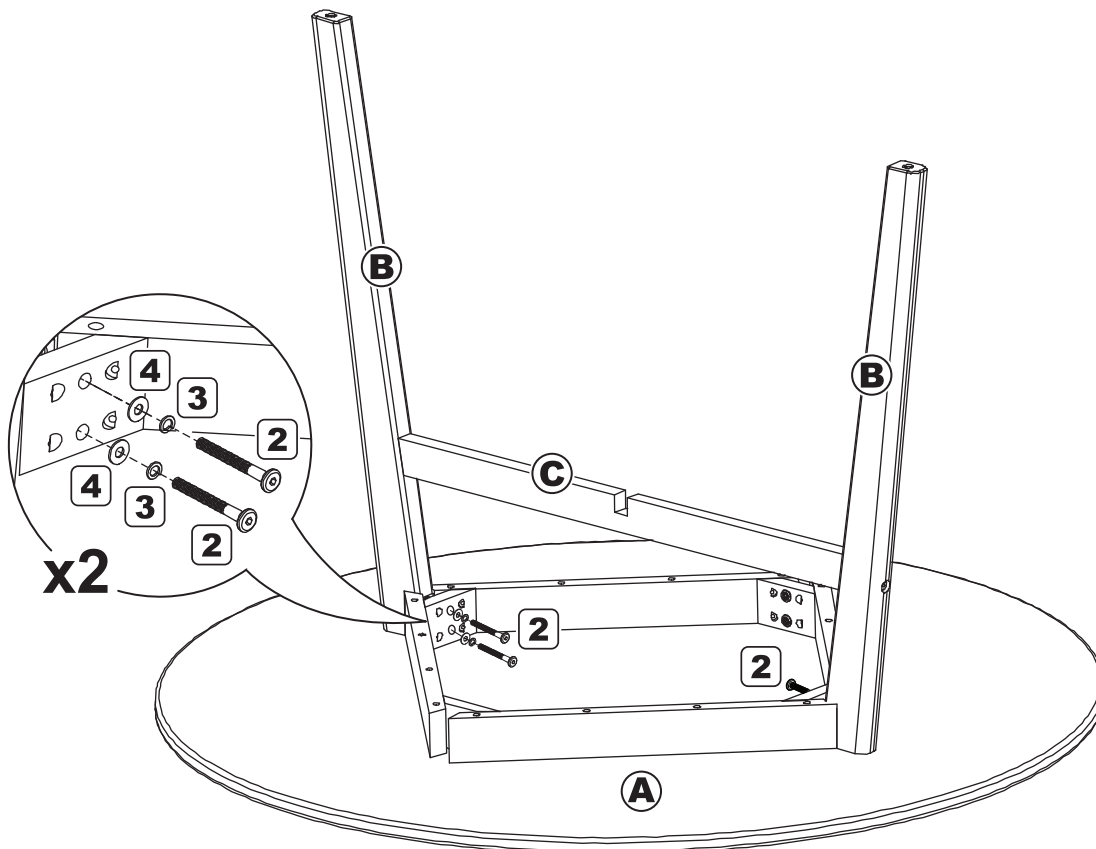

M6x60mm Tornillo De x4



Arandela Candado x4

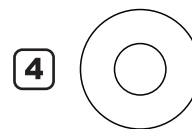

Arandela Plana x4

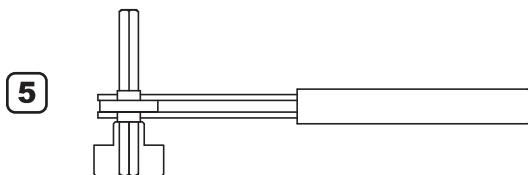

M4 Llave Ratchet x1

Instrucciones De Montaje Para La Mesa

3

1. Alinee y sujete el armazón de patas ensamblado (B, D) a la superficie de la Mesa (A) con Tornillo De (2), Arandela Candado (3), Arandela Plana (4).
Apriete los pernos con la Llave Ratchet.
2. Asegure la Barra inferior (D) y la Barra superior (C) con Tornillo p/Madera (6).
Apriete el tornillo con la Llave Ratchet.
3. Luego, apriete completamente todos los Tornillo p/Madera, Tornillo De.

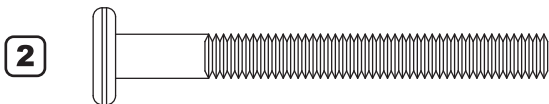
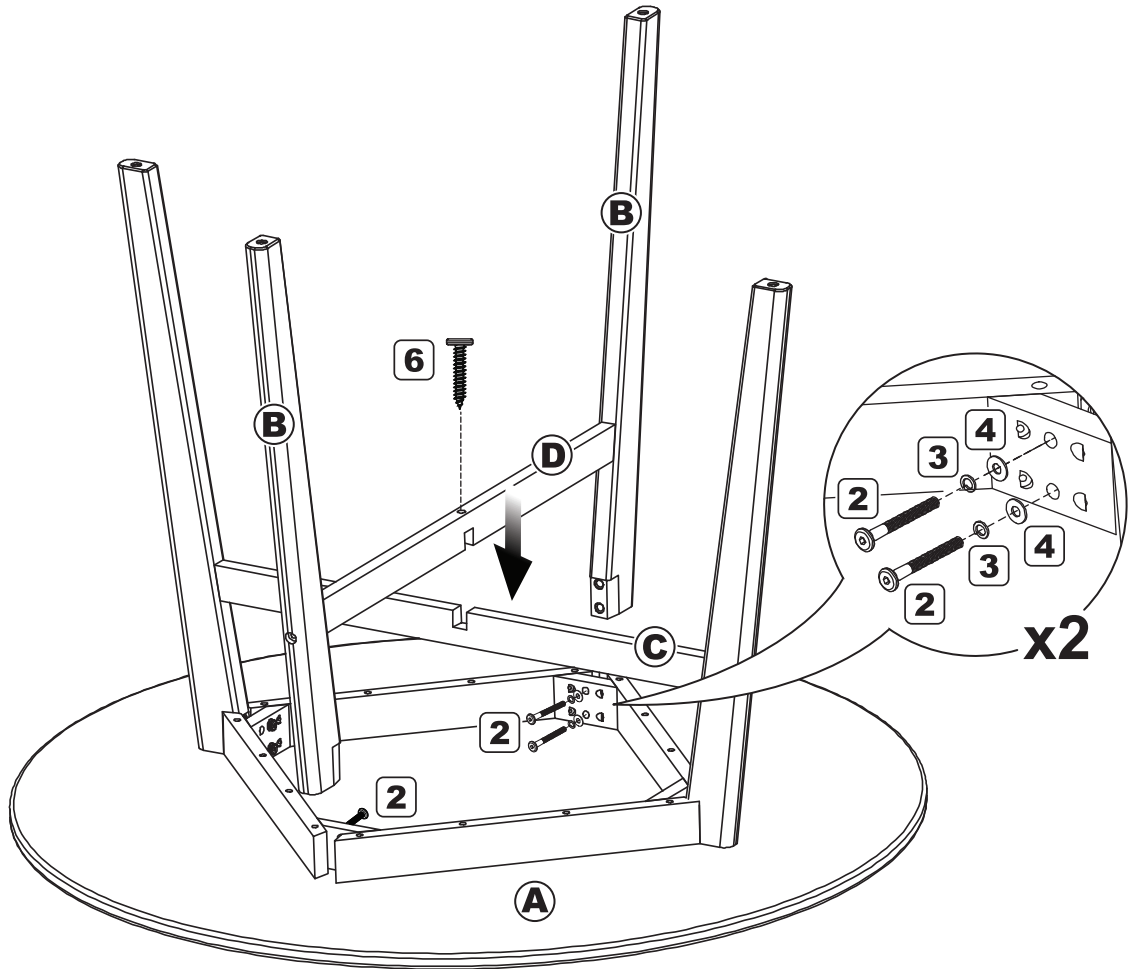

M6x60mm Tornillo De x4



Arandela Candado x4

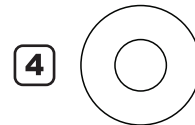

Arandela Plana x4

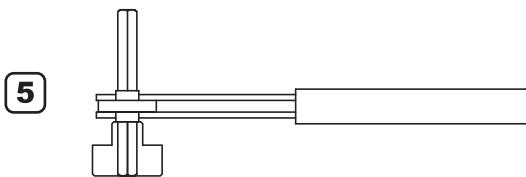

M4 Llave Ratchet x1

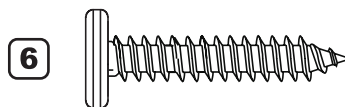

M6x30mm Tornillo p/Madera x1

Instrucciones De Montaje Para La Mesa

4

1. Coloque la mesa en posición vertical.
2. Cubra todos los orificios para tornillos de las patas de la mesa con Tapones De Madera (7).

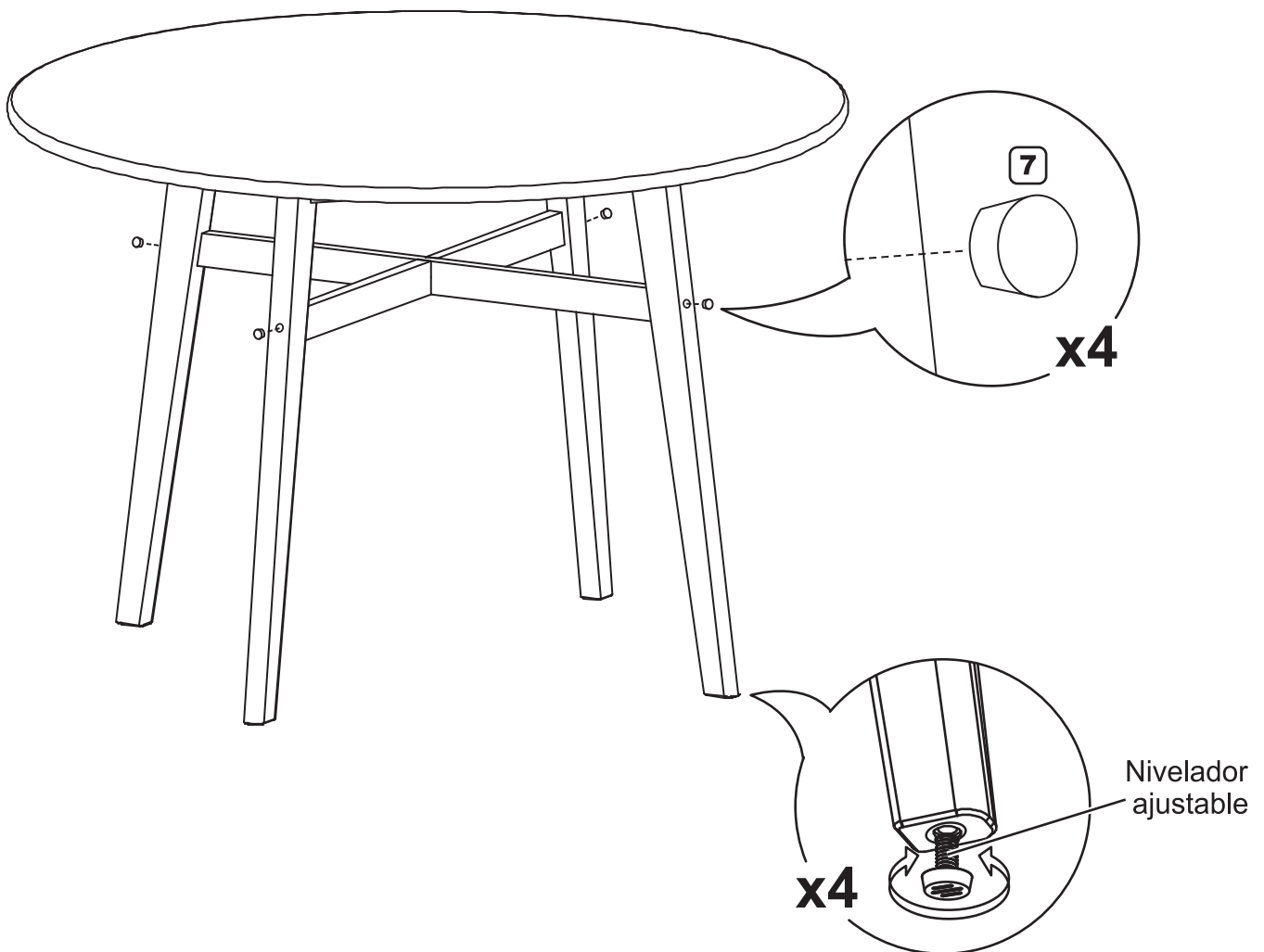

7

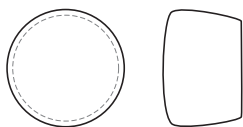

Tapones De Madera x4

Listado De Piezas Del Set

MODELO # MS1302125171002 (ACABADO NEGRO)
MODELO # MS1302125171003 (ACABADO NOGAL)

SI REQUIERE PEDIR UNA PARTE POR FAVOR USE LA LISTA DE ABAJO.

Por favor envíe la foto de los defectos y la prueba de compra a asprod2015@gmail.com.

Allí puede incurrirse en costos para las partes y de la carga si no hay comprobante de compra y después de los 90 días de la compra de la Walmart supermercado o Walmart.com

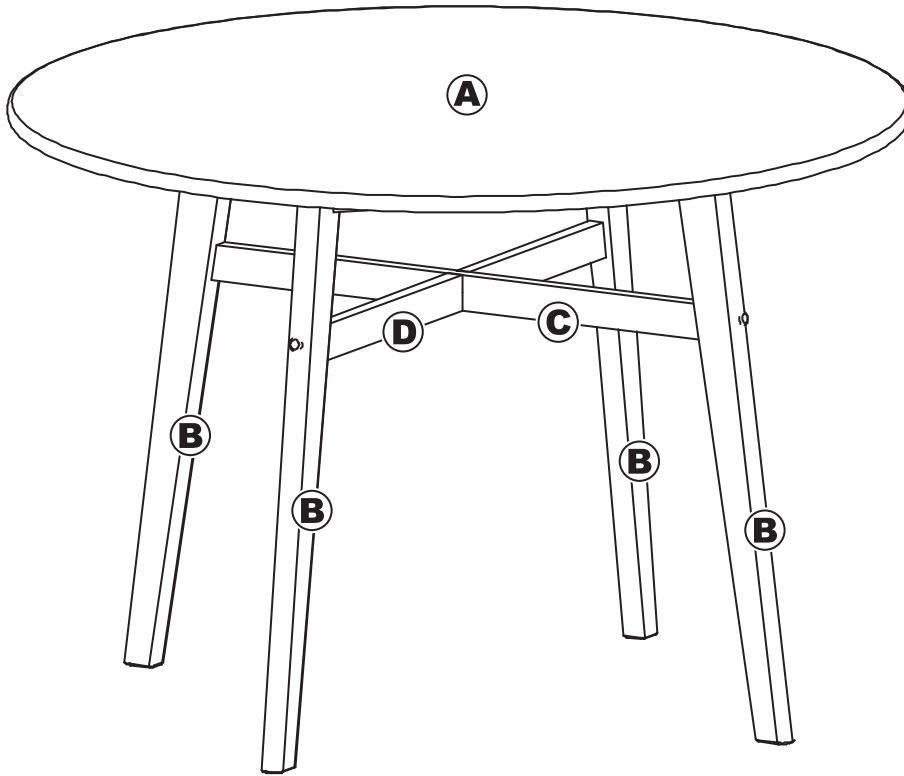

Partes

- A** Mesa
- B** Pata de la mesa
- C** Barra superior
- D** Barra inferior

- 1** M6x70mm Tornillo p/Madera
- 2** M6x60mm Tornillo De
- 3** Arandela Candado
- 4** Arandela Plana
- 5** M4 Llave Ratchet
- 6** M6x30mm Tornillo p/Madera
- 7** Tapones De Madera

Hardware

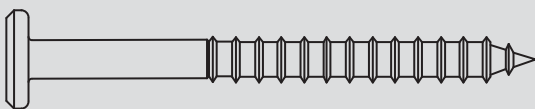

1

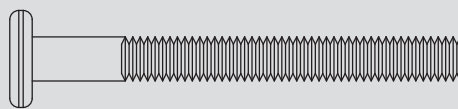

2



3



4

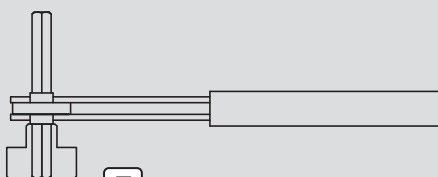

5

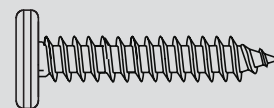

6



7